

PCIe-DAS1602/16

PCI Express Analog and Digital I/O Board



Features

- 16-bit resolution
- 16 single-ended (SE) or 8 differential (DIFF) analog input channels (switch-selectable)
- Up to 100 kS/s aggregate throughput (100 kS/s max for any channel)
- Two 12-bit analog outputs
- 32 digital I/O
- Three 16-bit counters
- 1 kS FIFO
- Connector- and software-compatible with the PCIM-DAS1602/16

Software

Supported Operating Systems

- Windows® 8/7/Vista®/XP, 32/64-bit
- Linux® open-source driver support

Ready-to-Run Applications

- InstaCal™ (install, configure, and test)
- TracerDAQ® (acquire, view, log, and generate)

Supported Programming Environments

- Visual Studio® and Visual Studio .NET, including examples for Visual C++®, Visual C#®, Visual Basic®, and Visual Basic .NET
- NI LabVIEW™ (Windows only)
- DASyLab®
- MATLAB® (Data Acquisition Toolbox™)

Overview

The PCIe-DAS1602/16 is a multifunction measurement and control board designed for the PCI Express (PCIe) bus. The board provides 16 SE or eight DIFF input channels with 16-bit resolution, two 12-bit analog outputs, 32 DIO, and three 16-bit counters.

The PCIe-DAS1602/16 is a fully connector- and software-compatible replacement for the Measurement Computing PCIM-DAS1602/16.



The PCIe-DAS1602/16 provides 16 single-ended or eight differential analog inputs, sample rates up to 100 kS/s, two 12-bit analog outputs, 32 digital I/O, and three 16-bit counters

Signal Connections

A 37-pin connector provides access to the 16 SE/8 DIFF analog inputs, two analog outputs, four digital and outputs, and three counter/timer channels.

A 40-pin connector provides access to 24 DIO connections.

Analog Input

The PCIe-DAS1602/16 provides 16 SE or eight DIFF analog inputs. The input mode is switch-selectable to configure all channels as either SE or DIFF.

The board offers bipolar analog input ranges of ± 10 V, ± 5 V, ± 2.5 V, and ± 1.25 V, and unipolar ranges of 0 V to 10 V, 0 V to 5 V, 0 to 2.5 V, and 0 V to 1.25 V.

Input ranges are software-selectable, and polarity is switch-selectable.

Sample Rate

The PCIe-DAS1602/16 offers a single-channel sample rate of 100 kS/s divided by the number of channels being sampled.

Analog Output

Two 12-bit multiplying digital-to-analog converters (DACs) provide analog output on the PCIe-DAS1602/16. DAC0 and DAC1 each accept a precision 5 V or 10 V reference, which provides onboard D/A unipolar ranges of 0 V to 5 V and 0 V to 10 V, and bipolar ranges of ± 5 V and ± 10 V.

Other ranges between 0 V and 10 V are available when an external precision voltage reference is supplied to the DAC0 REF IN pin or DAC1 REF IN pin of the main connector.

Onboard reference voltage, user-supplied reference voltage, and polarity are all jumper-selectable.

Digital I/O

The 24 digital I/O connections available on the 40-pin DIO connector of the PCIe-DAS1602/16 are available as two eight-bit ports (ports A and B) and two four-bit ports (ports CH and CL). Each port can be configured independently as either input or output. These ports default to the input state (high impedance) on power up or reset.

PCIe-DAS1602/16

General Information

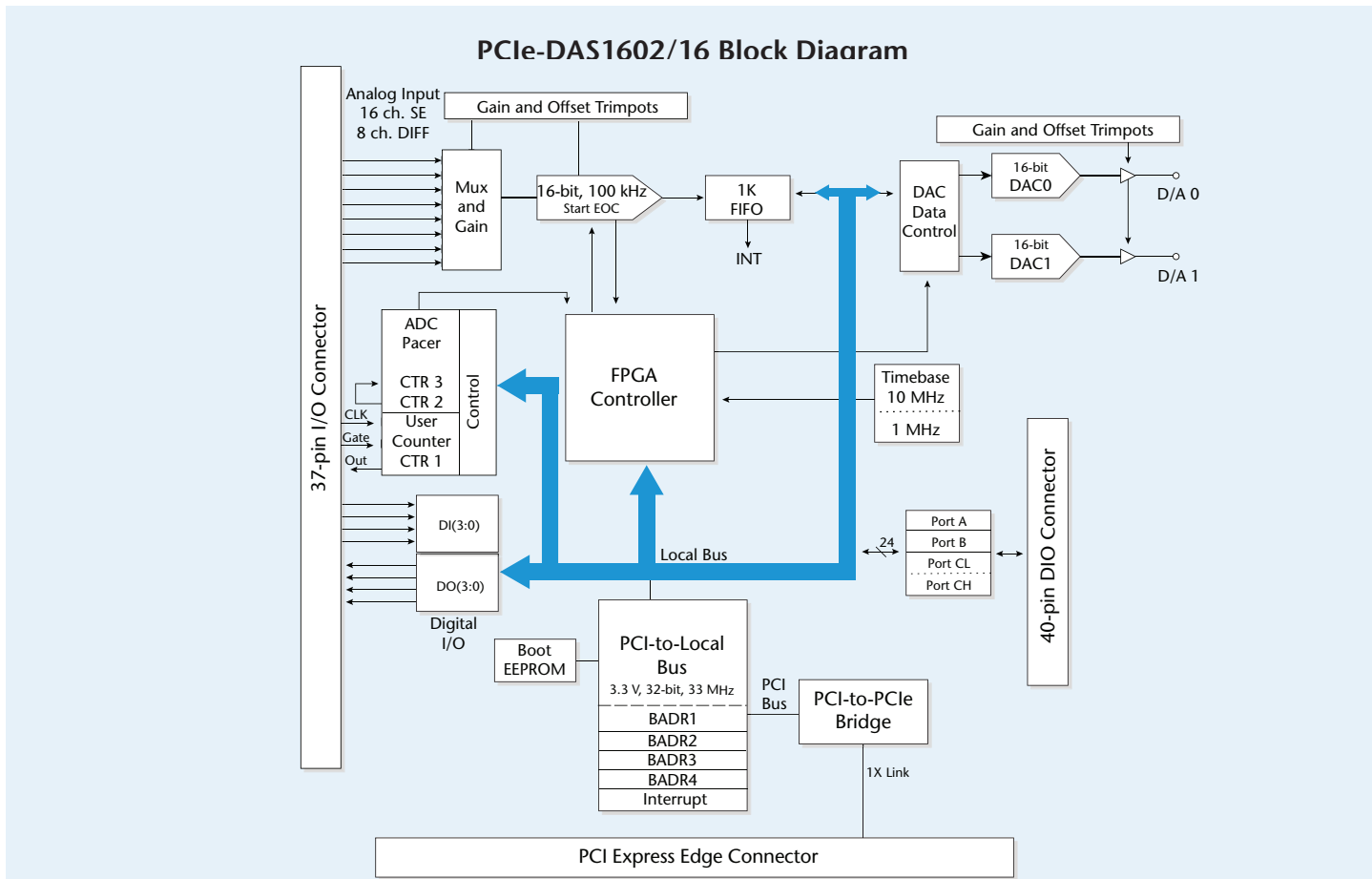

The eight digital I/O connections available on the main 37-pin connector consist of two 4-bit ports. One port is permanently configured as input, and the other port is permanently configured as output.

Pull-Up/Down Configuration

The PCIe-DAS1602/16 includes jumpers to set the digital bits for pull-up (+5 V) or pull down (0 V) when the board is powered on and reset. Ports A, B, CH, and CL are factory-configured for pull-up (+5 V).

Counter/Timer I/O

Each PCIe-DAS1602/16 offers three 16-bit down counters. Each counter accepts frequency inputs up to 10 MHz, and provides clock, gate, and output connections.

The frequency of the square wave used as a clock by the A/D pacer circuitry is jumper-selectable for 1 MHz (default), or 10 MHz. The internal pacer output driving the A/D converter is also available at pin 20 (CTR 3 Output) on the main 37-pin I/O connector.

Connect the counter clock to the onboard 10 MHz crystal oscillator, or leave unconnected for user input.

The A/D pacer clock trigger edge (rising or falling) that initiates the A/D conversions is jumper-selectable on the PCIe-DAS1602/16. The jumper is configured for rising edge by default.

Calibration

Field Calibration

Calibrating the PCIe-DAS1602/16 requires the following equipment:

- a precision (or non-precision) voltage source
- a 5½ digit digital voltmeter
- a few pieces of wire are required.
- a jeweler's screwdriver to adjust the trim pots

An extender card is not required to calibrate the board.

For normal environments, calibrate the PCIe-DAS1602/16 every six months to a year using software.

PCIe-DAS1602/16

Software



Calibrate the A/D converters by applying a known voltage to an analog input channel and adjusting trim pots for offset and gain. Three trim pots require adjustment to calibrate the analog input section of the board. There are also three pots associated with each of the analog output channels.

Calibrate the PCIe-DAS1602/16 for the range you intend to use it in. When the range is changed, slight variations in zero and full scale may result. These variations can be measured and removed in software if necessary.







If frequent variations in temperature or humidity are common, recalibrate at least every three months.

Factory Calibration

PCIe-DAS1602/16 devices are factory-calibrated. Specifications are guaranteed for one year. For calibration beyond one year, return the device to the factory for recalibration.

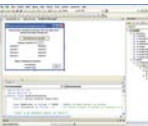
Software Support

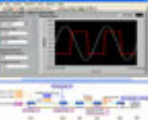
The PCIe-DAS1602/16 is supported by the software in the table below.

Ready-to-Run Applications		
InstaCal		An interactive utility that configures and tests MCC hardware. Windows OS InstaCal is included with the free MCC DAQ Software bundle (CD/download).
TracerDAQ and TracerDAQ Pro		A virtual strip chart, oscilloscope, function generator, and rate generator applications used to generate, acquire, analyze, display, and export data. Supported features may vary with hardware. The Pro version provides enhanced features. Windows OS TracerDAQ is included with the free MCC DAQ Software bundle (CD/download). TracerDAQ Pro is available as a purchased software download.
General-Purpose Programming Support		
Universal Library (UL)		Programming library of function calls for C, C++, VB, C# .Net, and VB .Net using Visual Studio and other IDEs. Windows OS The UL is included with the free MCC DAQ Software bundle (CD/download).
Linux Driver		Open-source Linux drivers are available for most MCC devices. Example programs are also provided.
Application-Specific Programming Support		
ULx for NI LabVIEW		A comprehensive library of VIs and example programs for NI LabVIEW that is used to develop custom applications that interact with most MCC devices. Windows OS ULx is included with the free MCC DAQ Software bundle (CD/download).
DASyLab Driver		Icon-based data acquisition, graphics, control, and analysis software that allows users to create complex applications in minimal time without text-based programming. DASyLab is available as a purchased software download. Windows OS
MATLAB Driver		High-level language and interactive environment for numerical computation, visualization, and programming. The Data Acquisition Toolbox, provided by The Mathworks, allows users to acquire data from most MCC PCI and USB devices. Visit www.MathWorks.com for more information on MATLAB Data Acquisition Toolbox support.

PCIe-DAS1602/16

Specifications

Specifications

All specifications are subject to change without notice.
Typical for 25 °C unless otherwise specified.

Analog Input

A/D converter type: LTC1605CSW

Resolution: 16 bits

Number of channels (switch-selectable): 16 SE/8 DIFF

Input ranges

Gain (software-selectable)

Unipolar/bipolar polarity (switch-selectable)

±10 V, ±5 V, ±2.5 V, ±1.25 V, 0 V to 10 V, 0 V to 5 V, 0 to 2.5 V, 0 V to 1.25 V

A/D pacing (software-selectable)

Internal counter: 82C54, positive or negative edge (jumper-selectable)

External source: Pin 25, positive or negative edge (software-selectable)

Software polled

A/D trigger (only available when internal pacing selected, software-Selectable)

External edge trigger: Pin 25, positive or negative edge (software-selectable)

A/D gate (only available when internal pacing selected, software-selectable)

External gate: Pin 25, high or low level (software-selectable)

Simultaneous sample and hold trigger

TTL output: Pin 26 (jumper-selectable); Logic 0 = Hold, Logic 1 = Sample

Burst mode (software-selectable): Burst interval = 10 us

Data transfer: From 1024 sample FIFO through interrupt with REPINSW,

Interrupt, Software polled

Interrupt: INTA# mapped to IRQ_n through PCI BIOS at boot-time

Interrupt enable: Programmable through PCI9030

Interrupt polarity: Active high level or active low level, programmable through PLX9030

Interrupt sources (software-selectable): End of conversion; FIFO not empty;

End of Burst; End of Acquisition; FIFO half full

A/D Conversion Time: 10 μs max

Throughput

Single channel: 100 kS/s

Multichannel: (100 kS/s)/(# of channels)

Common mode range: ±10 V min

CMRR @ 60 Hz: -100 dB typ, -80 dB min

Input leakage current: ±3 nA max

Input impedance: 10 MΩ min

Absolute maximum input voltage: 55 V/-40 V fault-protected through input mux

Analog Input Accuracy	
Typical Accuracy	±2.3 LSB
Absolute Accuracy	±5.0 LSB

Analog Input Accuracy Components	
Gain error	Trimable by potentiometer to 0
Offset error	Trimable by potentiometer to 0
PGA linearity error	±1.3 LSB typ, ±10.0 LSB max
Integral linearity error	±0.5 LSB typ, ±3.0 LSB max
Differential linearity error	±0.5 LSB typ, ±2.0 LSB max

Each PCIe-DAS1602/16 is tested at the factory to assure the overall error of the board does not exceed ±5 LSB.

Total board error is a combination of gain, offset, differential linearity, and integral linearity error. The theoretical absolute accuracy of the board may be calculated by summing these component errors. Worst case error is realized only in the unlikely event that each of the component errors is at their maximum level, and causes error in the same direction.

Analog Input Drift			
Range	Analog Input FS Gain Drift	Analog Input Zero drift	Overall Analog Input Drift
±10.00 V	2.2 LSB/°C max	1.8 LSB/°C max	4.0 LSB/°C max
±5.000 V	2.2 LSB/°C max	1.9 LSB/°C max	4.1 LSB/°C max
±2.500 V	2.2 LSB/°C max	2.0 LSB/°C max	4.2 LSB/°C max
±1.250 V	2.2 LSB/°C max	2.3 LSB/°C max	4.5 LSB/°C max
0 V to 10.00 V	4.1 LSB/°C max	1.9 LSB/°C max	6.0 LSB/°C max
0 V to 5.000 V	4.1 LSB/°C max	2.1 LSB/°C max	6.2 LSB/°C max
0 V to 2.500 V	4.1 LSB/°C max	2.4 LSB/°C max	6.5 LSB/°C max
0 V to 1.250 V	4.1 LSB/°C max	3.0 LSB/°C max	7.1 LSB/°C max

Absolute error change per °C temperature change is a combination of the gain and offset drift of many components. The theoretical worst case error of the board may be calculated by summing these component errors. Worst case error is realized only in the unlikely event that each of the component errors is at their maximum level, and causes error in the same direction.

The following table summarizes the worst case noise performance for the PCIe-DAS1602/16. Noise distribution is determined by gathering 50,000 samples with inputs tied to ground at the PCIe-DAS1602/16 main connector. Data is for both SE and DIFF modes of operation.

Noise Performance				
Range	±2 counts	±1 count	Max Counts	LSB _{rms}
±10.00 V	97%	80%	11	1.7
±5.000 V	97%	80%	11	1.7
±2.500 V	96%	79%	11	1.7
±1.250 V	96%	79%	11	1.7
0 V to 10.000 V	88%	65%	15	2.3
0 V to 5.000 V	88%	65%	15	2.3
0 V to 2.500 V	83%	61%	15	2.3
0 V to 1.250 V	83%	61%	16	2.4

Input noise is assumed to be Gaussian. An RMS noise value from a Gaussian distribution is calculated by dividing the peak-to-peak bin spread by 6.6.

Noise performance may be affected by input cabling and/or excessive noise from adjacent PCBs within the PC enclosure.

Crosstalk is defined here as the influence of one channel upon another when scanning two channels at the specified per channel rate for a total of 50,000 samples. A full-scale (FS) 100 Hz triangle wave is input on channel 1, with channel 0 tied to analog ground at the 37 pin user connector. The table below summarizes the influence of channel 1 on channel 0 and does not include the effects of noise.

PCIe-DAS1602/16

Specifications



Crosstalk			
Range	1 kHz Cross-talk (LSB pk-pk)	10 kHz Cross-talk (LSB pk-pk)	50 kHz Cross-talk (LSB pk-pk)
±10.000 V	4	13	24
±5.000 V	3	7	18
±2.5000 V	2	5	16
±1.250 V	3	4	14
0 V to 10.000 V	4	8	23
0 V to 5.000 V	3	5	16
0 V to 2.500 V	2	4	16
0 V to 1.250 V	3	3	16

Analog Output

D/A converter type: MX7548
 Resolution: 12 bits
 Number of channels: 2
 Channel type: SE voltage output
 Output range (jumper-selectable per output): ±10 V, ±5 V, 0 to 10 V, or 0 V to 5 V using onboard references, or user-defined using external reference
 Reference voltage (jumper-selectable)
 Onboard: -10 V and -5 V
 External: Independent (DAC0 REF IN pin 10 and DAC1 REF IN/SSH OUT pin 26)
 External reference voltage range: ±10 V max
 External reference input impedance: 10 kΩ min
 Data transfer (system-dependent): Programmed I/O
 Monotonicity: Guaranteed monotonic over temperature
 Slew rate: 2.0 V/μs min
 Settling time: 30 μs max to ±½ LSB for a 20 V step
 Current drive: ±5 mA min
 Output short-circuit duration: Indefinite at 25 mA
 Output coupling: DC
 Output impedance: 0.1 Ω max
 Output stability: Any passive load
 Coding: Offset binary
 Bipolar mode
 0 code = V_{ref}
 4095 code = -V_{ref} - 1 LSB, V_{ref} < 0 V
 -V_{ref} + 1 LSB, V_{ref} > 0 V
 Unipolar mode
 0 code = 0 V
 4095 code = -V_{ref} - 1 LSB, V_{ref} < 0 V
 -V_{ref} + 1 LSB, V_{ref} > 0 V
 Output voltage on power up and reset: 0 V ± 10 mV

Analog Output Accuracy	
Typical Accuracy	±1 LSB
Absolute Accuracy	±2 LSB

Analog Output Accuracy Components	
Gain Error	Trimable by potentiometer to 0
Offset Error	Trimable by potentiometer to 0
Integral Linearity Error	±0.5 LSB typ, ±1 LSB max
Differential Linearity Error	±0.5 LSB typ, ±1 LSB max

Total board error is a combination of gain, offset, differential linearity and integral linearity error. The theoretical absolute accuracy of the board may be calculated by summing these component errors. Worst case error is realized only in the unlikely event that each of the component errors is at their maximum level, and causes error in the same direction.

Analog Output Drift	
Analog Output FS Gain Drift	±0.22 LSB/°C max
Analog Output Zero Drift	±0.22 LSB/°C max
Overall Analog Output Drift	±0.44 LSB/°C max

Absolute error change per °C temperature change is a combination of the gain and offset drift of many components. The theoretical worst case error of the board may be calculated by summing these component errors. Worst case error is realized only in the unlikely event that each of the component errors is at their maximum level, and causing error in the same direction.

Digital Input/Output

40-Pin Digital I/O Connector

Digital type: 82C55
 Number of I/O: 24
 Configuration per 82C55: 2 banks of 8 and 2 banks of 4, or 3 banks of 8, or 2 banks of 8 with handshake
 Input high: 2.0 V min, 5.5 V absolute max
 Input low: 0.8 V max, -0.5 V absolute min
 Output high: 3.0 V min @ -2.5 mA
 Output low: 0.4 V max @ 2.5 mA
 Power-up/reset state: Input mode (high impedance)
 Pull-up/pull-down resistors (jumper-selectable): All pins pulled up to +5 V by default through individual 47 kΩ resistors

37-Pin Main Connector

Digital output type: 74ACT244, power up/reset to LOW logic level
 Digital input type: 74AHCT373, pulled to logic high through 47 kΩ resistors
 Number of I/O: 8
 Configuration: 4 fixed input, 4 fixed output
 Output high: 2.7 V @ -0.4 mA min
 Output low: 0.5 V @ 8 mA max
 Input high: 2.0 V min, 7 V absolute max
 Input low: 0.8 V max, -0.5 V absolute min

Counter

Counter type: 82C54
 Configuration: 3 down counters, 16 bits each
 Counter 1 source (software-selectable)
 External source: Main connector pin 21*
 Internal source: 100 kHz
 Counter 1 gate: External gate from main connector pin 24*
 Counter 1 output: Available from main connector pin 2
 Counter 2 source (jumper-selectable): Internal 1 MHz; internal 10 MHz
 Counter 2 gate (software-selectable): External source from main connector pin 25*
 Counter 2 output: Internal only, chained to counter 3 source
 Counter 3 source: Counter 2 output
 Counter 3 gate (software-selectable): External source from main connector pin 25*
 Counter 3 output: Available from main connector pin 20; programmable as A/D converter pacer clock.
 Clock input frequency: 10 MHz max
 High pulse width (clock input): 30 ns min
 Low pulse width (clock input): 50 ns min
 Gate width high: 50 ns min
 Gate width low: 50 ns min
 Input high: 2.0 V min, 5.5 V absolute max
 Input low: 0.8 V max, -0.5 V absolute min
 Output high: 3.0 V min @ -2.5 mA
 Output low: 0.4 V max @ 2.5 mA
 Crystal oscillator frequency: 10 MHz
 Frequency accuracy: 50 ppm

* Pins 21, 24, and 25 are pulled to logic high through 47 kΩ resistors

PCIe-DAS1602/16

Ordering



Power Consumption

3.3 V quiescent: 500 mA typ, 750 mA max
12 V quiescent: 100 mA typ, 150 mA max
User 5 V outputs: 10 mA

Environmental

Operating temperature range: 0 °C to 70 °C
Storage temperature range: -40 °C to 100°C
Humidity: 0% to 95% non-condensing

Mechanical

Board dimensions (L × W × H): 168 × 111 × 19 mm (6.6 × 4.4 × 0.7 in.)

Bus

Bus type: PCI Express 1.0a
Bus width: x1 lane PCI Express

Main Connector

Connector type: 37-pin male D connector
Connector compatibility: Identical to PCIM-DAS1602/16 connector

Digital I/O Connector

Connector type: 40-pin header
Connector compatibility: Identical to PCIM-DAS1602/16 connector

Ordering Information

Part No.	Description
PCIe-DAS1602/16	16-channel, 16-bit, 100 kS/s multifunction PCI Express board

Accessories and Cables

Part No.	Description
BP40-37	Backplate and cable assembly with 40-pin IDC female to 37-pin D male for CIO boards
C37FF-x	Cable, 40-conductor ribbon, female to female, x = 2, 3, 4, 5, 10, 15, 20, 25, or 50 feet
CIO-MINI37	Universal screw-terminal board, 37-pin
CIO-MINI37-VERT	Universal screw-terminal board, 37-pin D male connector, vertical
C37FFS-x	Cable, ribbon, 40-pin female IDC to 37-pin female D shell, x = 5 or 10 feet
CIO-TERMINAL	Universal screw-terminal board, prototyping area 37 terminals
SCB-37	Signal connection box, 37-conductor, shielded

Signal Conditioning Options

The PCIe-DAS1602/16 is compatible with many Measurement Computing signal conditioning products. Refer to the PCIe-DAS1602/16 product page at www.mccdaq.com/pci-data-acquisition/PCIe-DAS1602-16.aspx for a list of compatible accessories.

Software also Available from MCC

Part No.	Description
TracerDAQ Pro	Virtual strip chart, oscilloscope, function generator, and rate generator applications used to generate, acquire, analyze, display, and export data – professional version with enhanced features.
DASYLab	Icon-based data acquisition, graphics, control, and analysis software that allows users to create complex applications in minimal time without text-based programming.