

The E-TC device offers eight thermocouple channels and eight DIO channels which are bit-configurable for input or output. Output bits can be further configured as thermocouple alarms.

Features

- Eight 24-bit differential thermocouple (TC) inputs with TC channel-to-host isolation
 - 4 S/s per channel maximum sample rate
 - Two integrated cold junction compensation (CJC) sensors
 - Open thermocouple detection
 - Supports J, K, R, S, T, N, E, and B type thermocouples
- 8 digital I/O isolated from TC inputs and host
 - Digital outputs configurable as TC alarms
 - ± 24 mA drive capability
- 10/100 Ethernet interface
- Required +5 V external power adapter included

Supported Operating Systems

- Windows 10/8/7/Vista® 32/64-bit
- Android™

Overview

The E-TC offers high-accuracy temperature measurement with an Ethernet interface. The device offers the best value per channel and the best possible accuracy because the accuracy of the internal measurement electronics exceeds the accuracy specifications of the thermocouple sensors.

The E-TC is functionally equivalent to the USB-TC, making application migration very easy.

Ethernet Interface

The E-TC has a built-in high-speed communication port. Users can remotely access and configure the device with software over the Internet.

Thermocouple Input

Connect up to eight differential thermocouple (TC) input channels to the E-TC. The E-TC supports a maximum sample rate of 4 S/s per channel, and TC types J, K, R, S, T, N, E, and B. TC types are software-selectable per channel.

Cold-Junction Compensation

The E-TC has two high-resolution cold-junction compensation (CJC) sensors (one per four TC inputs).

Open-Thermocouple Detection

The E-TC is equipped with open-thermocouple detection (OTD) for all TC input channels. With OTD enabled, users can monitor for broken or disconnected TCs.

Digital I/O

The E-TC has eight digital I/O channels that are electrically isolated from the analog circuits. Each bit is individually configurable for input or output.

Data can be transferred at rates up to 5 kS/s when the device and host are connected by Ethernet to the same local network. Typical throughput is system-dependent.

All DIO channels are pulled high by default to 5 V through 47 k Ω resistors with a jumper on the circuit board. Each jumper configures the digital port for pull-up or pull-down.

Temperature Alarms

Each digital output can be optionally configured as an alarm for each TC input. When an alarm is enabled, the output line associated with the alarm is driven to the appropriate state determined by the alarm options and input temperature.

Use the alarm outputs to control a device or application that indicates when a temperature threshold has been exceeded, or to indicate an OTC condition.

Counter Input

The 32-bit event counter pin counts TTL pulses, and accepts frequency inputs up to 10 MHz.

Power

The E-TC requires external power from the 5 volt, 1 amp power adapter (PS-5V1AEPS) included with the device.





Calibration

The E-TC is factory-calibrated using a NIST-traceable calibration process. Specifications are guaranteed for one year. For calibration beyond one year, return the device to the factory for recalibration.

The E-TC also offers field calibration so that users can calibrate a device locally.

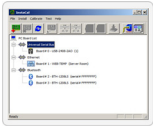
Software Support

The E-TC is supported by the software in the table below.

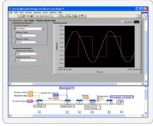
Ready-to-Run Applications	
DAQami™	 <p>Data acquisition companion software with drag-and-drop interface that is used to acquire, view, and log data, and generate signals. DAQami can be configured to log analog, digital, and counter channels, and to view that data in real-time or post-acquisition on user-configurable displays. Logged data can be exported for use in Excel® or MATLAB®. Windows OS</p> <p>DAQami is included with the free MCC DAQ Software bundle (CD/download). Install DAQami and try the fully-functional software for 30 days. After 30 days, all features except for data logging and data export will continue to be available – data logging and data export features can be unlocked by purchasing the software.</p>
InstaCal™	 <p>An interactive installation, configuration, and test utility for MCC hardware. Windows OS</p> <p>InstaCal is included with the free MCC DAQ Software bundle (CD/download).</p>
TracerDAQ™ and TracerDAQ Pro	 <p>Virtual strip chart, oscilloscope, function generator, and rate generator applications used to generate, acquire, analyze, display, and export data. Supported features may vary by hardware. The Pro version provides enhanced features. Windows OS</p> <p>TracerDAQ is included with the free MCC DAQ Software bundle (CD/download). TracerDAQ Pro is available as a purchased software download.</p>
General-Purpose Programming Support	
Universal Library™ (UL)	 <p>Library for developing applications in C, C++, VB, C# .Net, and VB .Net, and Python. Windows OS</p> <p>The UL is included with the free MCC DAQ Software bundle (CD/download).</p>
UL for Android™	 <p>Programming library of Java classes for programmers who develop apps for Android-based tablets and phones. UL for Android communicates with select MCC DAQ devices. Supports Android project development on Windows, Linux, Mac OS X</p> <p>UL for Android is included with the free MCC DAQ Software bundle (CD/download).</p>
Linux® driver	 <p>Open-source Linux drivers are available for most MCC devices. Example programs are also provided.</p>
Application-Specific Programming Support	
ULx for NI LabVIEW™	 <p>A comprehensive library of VIs and example programs for NI LabVIEW that is used to develop custom applications that interact with most MCC devices. Windows OS</p> <p>ULx for NI LabVIEW is included with the free MCC DAQ Software bundle (CD/download).</p>
DASYLab®	 <p>Icon-based data acquisition, graphics, control, and analysis software that allows users to create complex applications in minimal time without text-based programming. Windows OS</p> <p>DASYLab is available as a purchased software download. An evaluation version is available for 28 days.</p>

E-TC Block Diagram

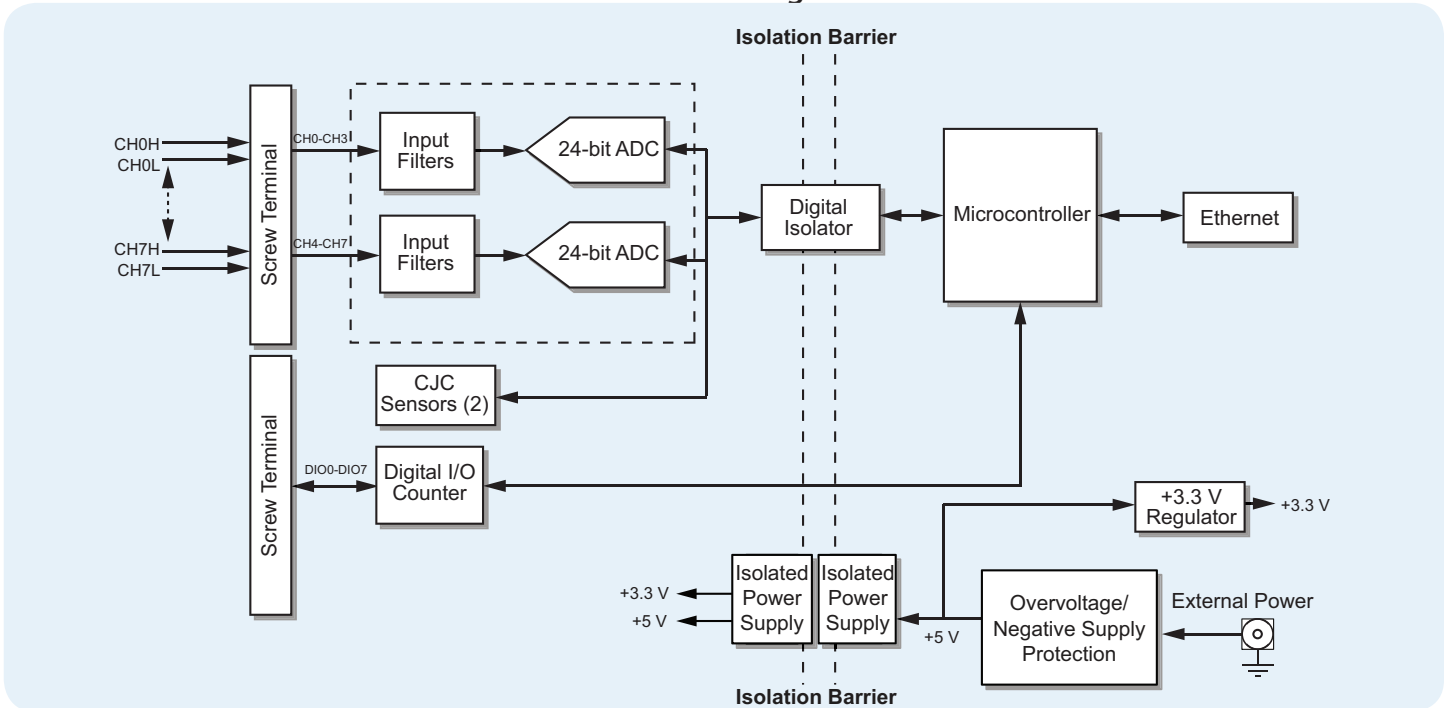

Specifications

All specifications are subject to change without notice.
Typical for 25 °C unless otherwise specified.

Thermocouple input

A/D converters: Delta-Sigma

ADC resolution: 24 bits

Number of channels: 8

Input isolation (between any TCx channel and digital/chassis ground):
500 VDC absolute max

Channel configuration: Software-selectable to match sensor type

Differential input voltage range: ± 0.128 V (calibration is performed at ± 70 mV)

Absolute maximum input voltage between any two TCx inputs: ± 25 V (power on), ± 25 V (power off)

Differential input impedance: 40 M Ω

Input current

Open thermocouple detect disabled: 1 nA

Open thermocouple detect enabled: 65 nA

Common mode rejection ($f_{in} = 50$ Hz or 60 Hz): 100 dB

Noise rejection: $f_{in} = 50$ Hz or 60 Hz: 75 dB

Input bandwidth: 10 Hz

Crosstalk between any two TCx inputs: -90 dB

Sample rate: 4 Hz max (per channel)

The enabled thermocouple inputs are continuously converted at the maximum A/D converter rate. If channels are enabled and have an open thermocouple connection, the sample rate will be lower.

Input noise: 250 nV rms

Gain error: 0.006 %

Offset error: 3 μ V

Measurement sensitivity

Thermocouple type J,K,T,E,N: 0.09 °C

Thermocouple type R,S: 0.11 °C

Thermocouple type B: 0.13 °C

Measurement sensitivity is the smallest change in temperature that can be detected.

Warm-up time: 20 minutes min

Open thermocouple detect response time: 1 second

CJC sensor accuracy (0 °C to 45 °C): ± 0.20 °C typ, ± 0.40 °C max

Calibration method: Factory

Recommended warm-up time: 20 minutes min

Calibration interval: 1 year (factory calibration)

Channel configurations

Channel configuration is stored on EEPROM external to the isolated microcontroller by the firmware whenever any item is modified. Modification is performed by commands issued over Ethernet from an external application, and the configuration is made non-volatile through the use of the EEPROM.

Thermocouple (J, K, S, R, B, E, T, or N; the factory default configuration is Type J): 8 differential channels

Compatible thermocouples

J: -210 °C to 1200 °C

K: -270 °C to 1372 °C

R: -50 °C to 1768 °C

S: -50 °C to 1768 °C

T: -270 °C to 400 °C

N: -270 °C to 1300 °C

E: -270 °C to 1000 °C

B: 0 °C to 1820 °C

Accuracy

Thermocouple measurement accuracy specifications include polynomial linearization, cold junction compensation, and system noise. The accuracy specifications assume the device is operated within its enclosure and has been warmed up for the recommended 20 minutes. Errors shown do not include inherent thermocouple error. Contact your thermocouple supplier for details on the actual thermocouple accuracy error.

When thermocouples are attached to conductive surfaces, the voltage differential between multiple thermocouples must remain within ± 1.8 V. For best results MCC recommends using electrically insulated thermocouples when possible.

Thermocouple Measurement Accuracy, including CJC Measurement Error All Specifications are (\pm).					
Sensor Type	Sensor Temperature ($^{\circ}$ C)	Accuracy Error Maximum ($^{\circ}$ C), 15 $^{\circ}$ C to 35 $^{\circ}$ C	Accuracy Error Typical ($^{\circ}$ C), 15 $^{\circ}$ C to 35 $^{\circ}$ C	Accuracy Error Maximum ($^{\circ}$ C), 0 $^{\circ}$ C to 45 $^{\circ}$ C	Accuracy Error Typical ($^{\circ}$ C), 0 $^{\circ}$ C to 45 $^{\circ}$ C
J	-210	1.896	0.823	2.228	0.990
	0	0.760	0.328	0.815	0.364
	1200	0.717	0.324	1.336	0.585
K	-210	2.196	0.938	2.578	1.141
	0	0.787	0.334	0.848	0.377
	1372	0.974	0.431	1.807	0.786
S	-50	2.144	0.711	2.566	1.053
	250	1.595	0.528	1.888	0.775
	1768	0.750	0.178	1.759	0.649
R	-50	2.266	0.749	2.715	1.113
	250	1.617	0.534	1.917	0.786
	1768	0.631	0.148	1.579	0.584
B	250	1.934	0.453	2.552	0.977
	700	0.740	0.179	1.128	0.439
	1820	0.482	0.137	1.213	0.492
E	-200	1.700	0.742	1.987	0.884
	0	0.752	0.327	0.806	0.360
	1000	0.629	0.285	1.142	0.500
T	-200	1.920	0.817	2.253	0.993
	0	0.801	0.339	0.870	0.385
	400	0.519	0.223	0.702	0.308
N	-200	2.125	0.876	2.518	1.101
	0	0.857	0.351	0.940	0.412
	1300	0.668	0.291	1.352	0.585

Digital input/output

Digital type: 5 V TTL input / CMOS output

Number of I/O: One port of 8 bits, shared with temperature alarms

Configuration: Each bit can be independently configured for input or output.

Power on conditions: Power on reset is input mode, except when bits are configured to operate as alarms.

Pull-up/pull-down configuration: The port has 47 k Ω resistors configurable as pull-up (default) or pull-down via internal jumper W1.

Digital I/O transfer rate (system paced): 100 to 5000 reads/writes per second typ on a local network

This is the typical throughput when the device and host are both connected by Ethernet to the same local network. Throughput can vary significantly, and typical throughput is not guaranteed, if a wireless connection is involved or data is sent over the internet.

Power on and reset state: All bits are input unless the temperature alarm functionality is enabled for them.

Input high voltage threshold: 2.0 V min

Input high voltage limit: 5.5 V absolute max

Input low voltage threshold: 0.8 V max

Input low voltage limit: -0.5 V absolute min, 0 V recommended min

Output high voltage: 4.4 V min (IOH = -50 μ A); 3.76 V min (IOH = -24 mA)

Output low voltage: 0.1 V max (IOL = 50 μ A); 0.44 V max (IOL = 24 mA)

Temperature alarms

Number of alarms: 8 (one per digital I/O line)

Alarm functionality: Each alarm controls its associated digital I/O line as an alarm output. When an alarm is enabled, the I/O line that is associated with the alarm is set to output and driven to the appropriate state determined by the alarm options and input temperature. The alarm configurations are stored in non-volatile memory and loaded at power on.

Alarm input modes (T1 and T2 can be independently set for each alarm)

Alarm when input temperature \geq T1, reset alarm when input temperature $<$ T2

Alarm when input temperature \leq T1, reset alarm when input temperature $>$ T2

Alarm when input temperature is $<$ T1 or $>$ T2

Alarm error modes

- Alarm on temperature reading only
- Alarm on temperature reading or open thermocouple error
- Alarm on open thermocouple error only

Alarm output modes

- Disabled, digital I/O line may be used for normal operation
- Enabled, active high output (DIO line goes high when alarm condition is met)
- Enabled, active low output (DIO line goes low when alarm condition is met)

Alarm latency: 1 second

Alarm settings are applied when changed and at power-on. Temperatures are constantly converted on enabled channels and processed for alarm conditions regardless of the communications connectivity.

Counter

Counter type: Event counter

Number of channels: 1

Input type: Schmitt trigger; fixed 47.5 kΩ pull-down resistor

Resolution: 32 bits

Schmitt trigger hysteresis: 0.6 V min, 1.7 V max

Input high voltage threshold: 1.9 V min, 3.6 V max

Input high voltage limit: 5.5 V absolute max

Input low voltage threshold: 1.0 V min, 2.3 V max

Input low voltage limit: -0.5 V absolute min, 0 V recommended min

Input frequency: 10 MHz max

High pulse width: 50 ns min

Low pulse width: 50 ns min

Memory

EEPROM: 4,096 bytes

Power

External power supply: 5 V ±5% required; 5 V, 1 A supply provided (PS-5V1AEPS)

Supply current: Quiescent current: 177 mA typ

This is the total quiescent current requirement for the device that includes the LEDs. This value does not include any potential loading of the digital I/O bits or +VO terminal.

User output voltage range (available at +VO terminal): 4.40 V min to 5.25 V max; assumes supplied AC adapter is used

User output current: Available at +VO terminal: 10 mA max

Isolation: Measurement system to chassis ground: 500 VDC min

Network**Ethernet connection**

Ethernet type: 100 Base-TX, 10 Base-T

Communication rates: 10/100 Mbps, auto-negotiated

Connector: RJ-45, 8 position

Cable length: 100 meters (328 feet) max

Additional parameters: HP Auto-MDIX support

Network interface

Protocols used: TCP (IPv4 only) and UDP

Network ports used

UDP: 54211 (discovery)

UDP: 6234 (bootloader only)

TCP: 54211 (commands)

Network IP configuration: DHCP + link-local, DHCP, static, link-local

Network name: E-TC-xxxxxxx, where xxxxxxx are the lower 6 digits of the device MAC address

Network name publication: By NBNS; responds to b-node broadcasts, therefore only available on the local subnet

Network Factory Default Settings

Factory default IP address: 192.168.0.101

Factory default subnet mask: 255.255.255.0

Factory default Gateway: 192.168.0.1

Factory default DHCP setting: DHCP + link-local enabled

Network Security

Security implementation: TCP sockets are not opened unless application sends the correct PIN connection code; stored in non-volatile memory; may be changed by user; default value is 0000

Number of concurrent sessions: 1

Vulnerabilities: TCP Sequence Number Approximation Vulnerability

LED displays and the Factory Reset button**Power LED (top)**

On: $4.2\text{ V} < V_{\text{ext}} < 5.6\text{ V}$

Off: $V_{\text{ext}} < 4.2\text{ V}$ or $V_{\text{ext}} > 5.6\text{ V}$ (power fault)

Power and Activity LEDs blink continuously in firmware update mode

Activity LED (bottom)

On: A valid host connection is established.

Blinks: A command is received.

Power and Activity LEDs blink continuously in firmware update mode

Ethernet connector LEDs

Left (green): Link/activity indicator; on when there is a valid Ethernet link, and blinks when network activity is detected.

Right (yellow): Speed indicator; on for 100 Mbps, off for 10 Mbps or no link.

Factory reset button: Resets network and alarm configuration settings to factory default values.

Press and hold for 4 seconds: The Power and Activity LEDs both blink twice and turn off to indicate that network settings have been restored to default values. Release the button to allow the device to reset and use the default settings. If the reset button is released before the two LEDs blink, settings are not affected

Hold the reset button at power on: Forces the device into firmware update mode in case of a failed firmware update. In this mode, both LEDs blink together constantly. The device may be returned to normal operation by cycling the power.

Environment

Operating temperature range: 0 °C to 55 °C

Storage temperature range: -40 °C to 85 °C

Humidity: 0 °C to 90% non-condensing

Mechanical

Dimensions: 117.9 × 82.8 × 29.0 mm (4.64 × 3.26 × 1.14 in.)

Screw terminal connector

Connector type: Screw terminal

Wire gauge range: 16 AWG to 30 AWG

Order Information

Part No.	Description
E-TC	Ethernet-based 24-bit, 8-channel thermocouple input device with 8 bit-configurable DIO lines. Includes, Ethernet cable, power supply, and MCC DAQ software CD. Functionally equivalent to the USB-TC.

Accessories and Cables

Part No.	Description
PS-5V1AEPS	5 volt, 1 amp power supply. Shipped with the E-TC – interchangeable plugs available separately
ACC-205	DIN-rail kit; compatible with the E-TC

Software also Available from MCC

Part No.	Description
DAQami	Data acquisition companion software for acquiring data and generating signals
TracerDAQ Pro	Out-of-the-box virtual instrument suite with strip chart, oscilloscope, function generator, and rate generator – professional version
DASyLab	Icon-based data acquisition, graphics, control, and analysis software