

The DBK65 is compatible with: WaveBook, ZonicBook, LogBook, DaqBook, DaqLab, DaqScan, and DaqBoard/2000 Series devices.

- Overview 1**
- DBK65 Power Requirements 2**
- Power Available for Transducers 2**
- DBK65 Voltage Regulation 2**
- Selecting an Excitation Voltage 3**
- Customizing a Voltage 4**
- Creating a 4 to 20mA Current Loop 5**
- Source Impedance and Settling Time 6**
- Configuring the DBK65 Address 7**
- Configuring the Primary Data Acquisition Device 8**
- Connecting the DBK65 to Signals and to the Primary Data Acquisition Device 9**
- Software Setup 10**
- Calibrating a Transducer using the “Shunt Calibration” Technique 11**
- DBK65 Specifications 12**

Overview

The DBK65 is an 8 channel transducer interface module. Transducers of 2, 3, 4, and 6 wire type can be easily connected to the device by means of removable screw terminal blocks, 1 per channel.

The module is ideally suited for transducer outputs of the following types. Wiring schematics are provided on page 2 of this DBK65 section.

- 4 to 20 mA
- 3-wire string pots
- 4-wire bridge based transducers
- 6-wire bridge based transducers



DBK65

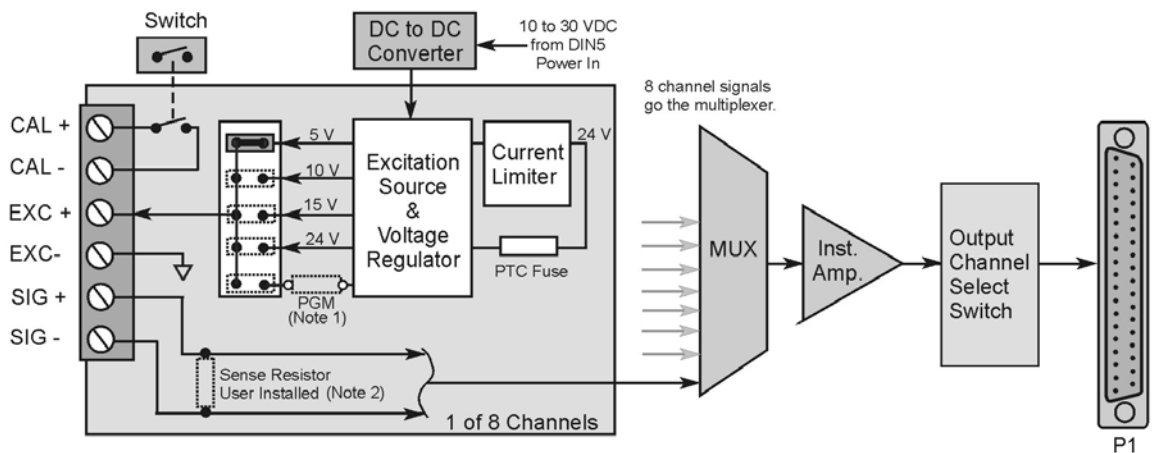

DBK65 Block Diagram

Note 1: The user can install a resistor for use with the programmable regulator. The programmable voltage source can be within the range of 5 to 20 VDC.

Note 2: The user can install a 250Ω resistor across the positive and negative signal lines (+Signal and -Signal) for 4 to 20 mA transducer outputs.

Each of the 8 channels can be set for a different excitation voltage. 5, 10, 15, and 24 VDC are provided internally from the DBK65 and are selected via placement of a jumper. In addition, a fifth jumper position can be used to select a custom voltage between 5 and 20 VDC. The user must install a resistor if this option is desired. The following section, *Customizing a Voltage*, contains additional information.

Each channel includes 2 screw terminals that allow for a relay closure. Designated as CAL+ and CAL-, the terminals can be used to switch in a calibration resistor for 6-wire transducers. Note that the DBK65's rear panel CAL switch will open or close the internal calibration switches for all 8 channels simultaneously.

DBK65 Power Requirements

The amount of DC power required, which is supplied to the DBK65 through its Power-In DIN5 connector, is 15 V @ 833 mA, 20 V @ 625 mA, assuming max load. In addition, the amount of power drawn from the P1-based host acquisition device, such as a Daq device or a LogBook is 25 mA from ± 15 V, 750 mW total. For purpose of our discussion here, a P1-based device is one which is connecting to the DBK65 via the DB37 (P1) connector.

Power Available for Transducers

At the excitation voltages available from the DBK65 (5 to 24 V) a single transducer will typically draw from 10 to 100mA. This fact and the per-channel and per-module current limits must be taken into account to avoid overloading the system.

- Total current available, for all 8 channels: 240mA.
- Current available for a single channel: 100mA.
- Transducer, typical current draw: 10 to 100mA

DBK65 Voltage Regulation

Better voltage regulation results in a lower variance of the source output voltage [excitation voltage], as load is applied. Graphs depicting DBK65 voltage regulation for excitation set at 5, 10, 15, and 24 V are included with the product's specifications.

The following graph is intended to provide a better understanding of voltage regulation. In the graph, the output voltage (V_{out}) exhibits less than $\pm 5\%$ variance from nominal voltage, i.e., 5, 10, 15, or 24 VDC. This also applies to the user settable 5 to 20 VDC.

The $\pm 5\%$ variance factor holds true up to the limiting current (Max Current). Refer to the graphs at the end of *Specifications* for typical voltage and current values.

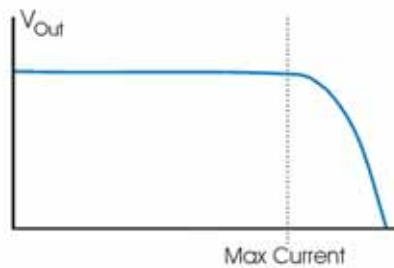

Typical Current Limiting Voltage Curve

Selecting an Excitation Voltage

Each channel has a voltage select header, which consists of 5 pairs of pins and a jumper. The jumper position determines the excitation voltage. Possible voltages are 5, 10, 15, and 24 VDC. A fifth possibility exists for a custom voltage that resides within the range of 5 to 20 V. To obtain a custom voltage you must install a resistor in the excitation line labeled “PGM.” The method is discussed shortly.

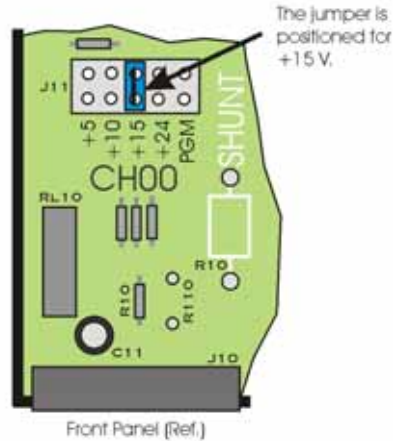

Reference for Selecting a Pre-Set Voltage Value



The discharge of static electricity can damage some electronic components. Semiconductor devices are especially susceptible to ESD damage. You should always handle components carefully, and you should never touch connector pins or circuit components unless you are following ESD guidelines in an appropriate ESD-controlled area. Such guidelines include the use of properly grounded mats and wrist straps, ESD bags and cartons, and related procedures.

WARNING



HOT COMPONENTS! Allow the DBK65 module to cool for at least 30 minutes before removing the top cover. Some internal components can become very hot and may cause burns.

To select a pre-set voltage (5, 10, 15, or 24V):

1. Remove the DBK65 from power and disconnect all signal lines.
2. Allow the unit to cool for at least 30 minutes.
3. Remove the 4 screws from the top cover plate. Then remove the plate.
4. Position the voltage select header's jumper to the desired setting. See the preceding figure.
5. Re-install the top cover plate and secure it with the 4 screws that were removed in step 3.

Customizing a Voltage

To make use of the custom voltage feature you will need to acquire a resistor of the calculated value. The formula to use is:

$$R_2 = (V_{\text{out}} - 1.2\text{V}) / 0.007645$$

Example:

Suppose you wanted an excitation source of 12V. Simply replace the V_{out} variable with 12V and solve for R_2 . Thus, $R_2 = (12 - 1.2) / 0.007645 = 1412.688\Omega$. In practice, a 1400 ohm, 1% resistor would be used.

Of course, 1400 Ω is a little off from the 1412.688 Ω , which was calculated. To see the actual nominal voltage that would result from 1400 Ω we can use a second equation.

$$V_{\text{out}} = 1.2\text{V} (1 + R_2/158) + 0.00005 * R_2$$

$$V_{\text{out}} = 1.2 (1 + 1400/158) + 0.00005 * 1400 = 11.903 \text{ volts}$$

After the resistor value is known, it can be installed as follows.



The discharge of static electricity can damage some electronic components. Semiconductor devices are especially susceptible to ESD damage. You should always handle components carefully, and you should never touch connector pins or circuit components unless you are following ESD guidelines in an appropriate ESD-controlled area. Such guidelines include the use of properly grounded mats and wrist straps, ESD bags and cartons, and related procedures.

WARNING



HOT COMPONENTS! Allow the DBK65 module to cool for at least 30 minutes before removing the top cover. Some internal components can become very hot and may cause burns.

1. Remove the DBK65 from power and disconnect all signal lines.
2. Allow the unit to cool for at least 30 minutes.
3. Remove the 4 screws from the top cover plate. Then remove the plate.
4. Remove solder from the 2 holes at the resistor mounting location.
5. Using rosin core solder and proper soldering technique, solder the resistor into position for the applicable channel. **Be sure that the resistor leads are short enough to avoid making contact with the metal chassis.**

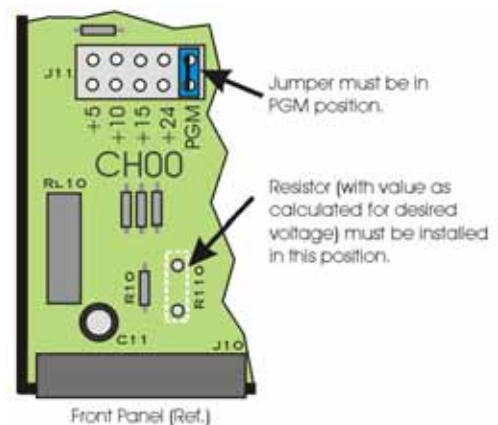

The figure to the right indicates the resistor location for use with channel 0 (CH00). The location scenario is similar for all 8 channels.

Refer to the following table for a channel's PGM Resistor Location number. The location numbers appear on the circuit board.

Channel	PGM Resistor Location	Voltage Out Jumper Header	Voltage Set V_{out}	Resistor Value R_2
CH00	R110	J11		
CH01	R120	J21		
CH02	R130	J31		
CH03	R140	J41		
CH04	R150	J51		
CH05	R160	J61		
CH06	R170	J71		
CH07	R180	J81		

- On the jumper header, reposition the channel's voltage out jumper to the "PGM" position. Refer to the table for a channel's applicable Jumper Header. The header numbers appear on the circuit board.
- If applicable, install resistors for other channels, and set the applicable voltage out jumper headers to PGM.
- Re-install the top cover plate and secure it with the 4 screws that were removed in step 3.

Creating a 4 to 20mA Current Loop

Inputs to monitor the commonly used 4 to 20mA current loops most often employ a 250 Ω precision resistor to develop a 1 to 5 VDC voltage drop.

Ideally, a resistor for such purpose should have a 0.1% tolerance (or better) with a minimum power rating of 0.25W and a temperature coefficient of at least 25ppm/ $^{\circ}$ C.

Lower values of resistance, for example, 62.5 Ω [for a lower voltage drop within the loop of 0.25 to 1.25 VDC] will require that the host data acquisition device use a gain of x4 to maximize the signal resolution.



The discharge of static electricity can damage some electronic components. Semiconductor devices are especially susceptible to ESD damage. You should always handle components carefully, and you should never touch connector pins or circuit components unless you are following ESD guidelines in an appropriate ESD-controlled area. Such guidelines include the use of properly grounded mats and wrist straps, ESD bags and cartons, and related procedures.

WARNING



HOT COMPONENTS! Allow the DBK65 module to cool for at least 30 minutes before removing the top cover. Some internal components can become very hot and may cause burns.

To create a 4 to 20mA current loop:

- Remove the DBK65 from power and disconnect all signal lines.
- Allow the unit to cool for at least 30 minutes.
- Remove the 4 screws from the top cover plate. Then remove the plate.
- Remove solder from the 2 holes at the resistor mounting location (see the following figure for location).

- Using rosin core solder and proper soldering technique, solder the resistor into position for the applicable channel. **Be sure that the resistor leads are short enough to avoid making contact with the metal chassis.**

The figure to the right indicates the resistor location for use with channel 0 (CH00). The location scenario is similar for all 8 channels.

- Re-install the top cover plate and secure it with the 4 screws that were removed in step 3.

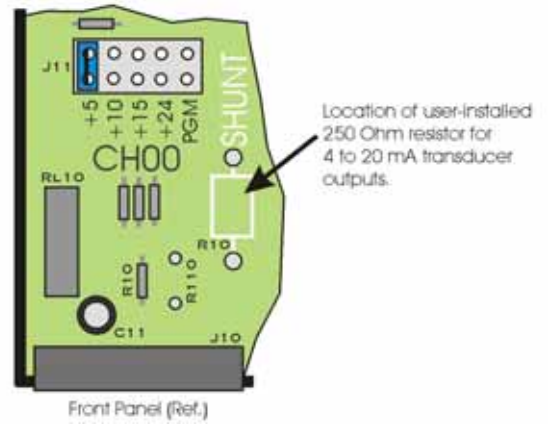

Source Impedance and Settling Time

High speed multiplexing of signal sources with non-zero impedance will result in reading errors caused by settling time. In the simplest form, a multiplexing system consists of a group of switches, with internal resistance, and an output capacitance at the input of an amplifier feeding an A/D converter with a sample-hold circuit on the input. During the short time a channel signal is connected to the A/D amplifier, the signal must charge the output capacitance to the true value of the signal so that the sample-hold captures an accurate value for the A/D converter to digitize. If the source has significant internal impedance the voltage reading will be reduced.

Source impedance below 1000 ohms will create negligible error. Above 1000 ohms, the effects are increasingly noticeable. An accurate source in series with a variable resistance will readily demonstrate this. Although the effect is exponential, an easy reference point to remember is that 25K of source impedance will result in approximately a 10% error.

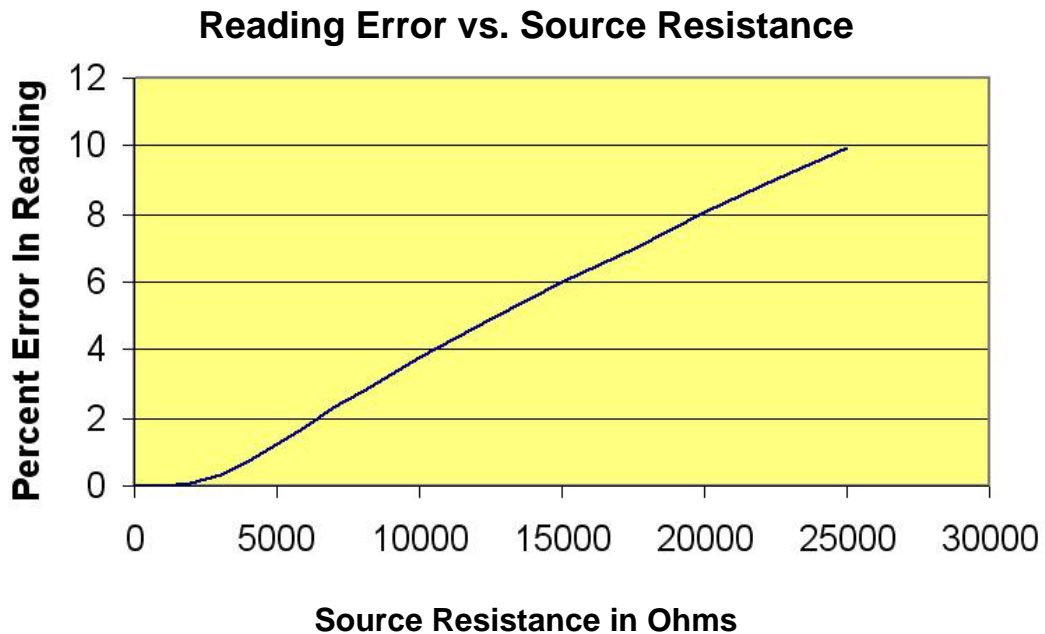

Configuring the DBK65 Address

You can connect 1 or 2 DBK65 modules to a single main channel on the primary data acquisition device. Thus, a 16-channel Daq device can support up to 32 DBK65 modules. Since each module has 8 input channels, a fully populated system can use 256 input sensors (32 modules x 8 channels per module). To keep the large number of inputs organized, each DBK65 module is given a unique address via its DIP switch, S1 [located on the rear panel].

CAUTION



Each DBK65 must be configured before connecting the module to inputs and outputs. In addition, adjustment of the channel address must only be performed when the system's power is OFF. Failure to do so may result in equipment damage.

S1's four leftmost micro-switches are used to set the module's channel address in binary. Set the micro-switches to the desired address only after ensuring that the system power is OFF. Several example address settings are provided below. Other settings can be easily derived.



Each DBK65 module in the system must have a unique channel address for the primary data acquisition device. Valid addresses are 0 to 15. Note that two modules can have a setting for the same primary channel, for example, two modules could be set to channel 0; as long as one module is set to "L" to indicate the lower sub-channels 0-7 and the other is set to "U" to indicate the upper sub-channels of 8-15. Examples of various settings follow.



Channel 0 / Lower

Primary Acquisition Device Channel 0 DBK65 Lower Sub-Channels 0-7

The four leftmost micro-switches are set to "0" (Open). This sets the unit to **primary acquisition device Channel 0**. The rightmost switch is at "L," setting the module to the **"lower" DBK65 sub-channels (0 through 7)**.

Note: If connecting a second module to primary device Channel 0, the U/L switch for that module would be set to "U" for sub-channels 8 thru 15.



Channel 5 / Lower

Primary Acquisition Device Channel 5 DBK65 Lower Sub-Channels 0-7

The micro-switches for binary 4 and binary 1 are closed. This sets the unit to **primary acquisition device Channel 5**. The rightmost switch is at "L," setting the module to the **"lower" DBK65 sub-channels (0 through 7)**.



Channel 15 / Lower

Primary Acquisition Device Channel 15 DBK65 Lower Sub-Channels 0-7

The micro-switches for binary 8, 4, 2, and 1 are closed, thus setting the **channel to "15"** (8 + 4 + 2 + 1) for the primary acquisition device. The rightmost switch is at "L," setting the module to the **"lower" DBK65 sub-channels (0 through 7)**.



Channel 2 / Upper

Primary Acquisition Device Channel 2 DBK65 Upper Sub-Channels 8-15

The micro-switch for binary 2 is closed, thus setting the **channel to "2"** for the primary acquisition device. The rightmost switch is at "U," setting the module to the **"upper" DBK65 sub-channels (8 through 15)**.

Configuring the Primary Data Acquisition Device

DaqBook/100 Series & /200 Series and DaqBoard [ISA type] Configuration

Use of a DBK65 with a DaqBook/100 Series, DaqBook/200 Series, or with an ISA-type DaqBoard device requires the configuration of jumpers JP1 and JP4 located on that device, as applicable.

1. If not using auxiliary power, set the JP1 jumper for **Analog Option Card Use** [also referred to as the expanded analog mode].

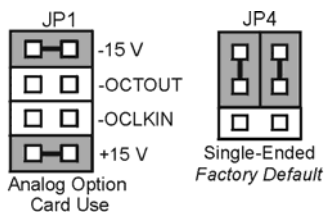

Note:
These jumpers do not apply to /2000 Series Devices.

Required Jumper Settings for DaqBook/100 Series, DaqBook /200 Series, and ISA-Type DaqBoards



The JP1 default position (above) is necessary to power the interface circuitry of the DBK65 via the internal ± 15 VDC power supply. **If using auxiliary power you must remove both JP1 jumpers.**

2. For DaqBook/100, DaqBook /112, and DaqBook /120 *only*, place the JP4 jumper in the *single-ended* mode.

Note: Analog expansion cards convert all input signals to single-ended voltages that are referenced to analog common.

DaqBook/2000 Series & DaqBoard/2000 Series

No jumper configurations are required on the DaqBook/2000 series and DaqBoard/2000 series devices in regard to connecting a DBK65.

LogBooks

No jumper configurations are required on LogBook devices in regard to connecting a DBK65.

Connecting the DBK65 to Signals and to the Primary Data Acquisition Device

You can connect the DBK65 module to your primary data acquisition device and to its signal inputs after you have completed the following:

- set the DBK65 module's address
- configured the DBK65 on a channel-by-channel basis for the application
- configured the primary data acquisition device, if applicable

You can connect up to eight sensors to one DBK65. A CA-37-x, CA-131-x, or a CA-255-xT cable is used to connect the module to a LogBook or Daq device via DB37 connectors (P1).

To connect a DBK65 to a WaveBook or ZonicBook, refer to the final portion of this section, [Connecting to a BNC Connector](#).



If your system needs to be CE Compliant, be sure to read the applicable *Declarations of Conformity* prior to connecting the DBK65.

Connect the DBK65 module as follows.

1. Connect each input to a screw terminal block on the DBK65. Example wiring diagrams are provided below. Note that the screw-terminal blocks can be removed from the DBK65 to allow for easier wiring.

CAUTION



Do not connect the excitation source to a non-isolated, powered transducer. Making such a connection can cause damage to both the DBK65 and to the transducer.

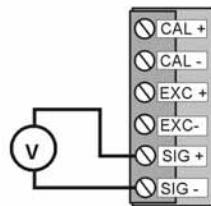

2-Wire Volts

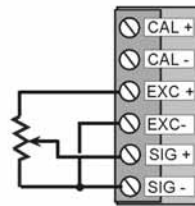

3-Wire Transducer

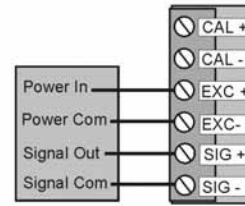

4-Wire Transducer

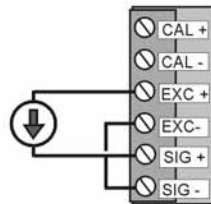

2-Wire Transducer
with 4 to 20 mA output

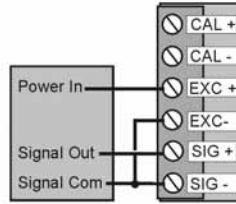

3-Wire Transducer

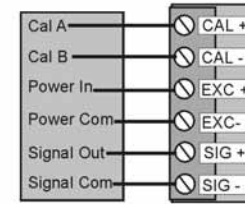

4-Wire Transducer
with internal calibration

Wiring Scenarios

A Note Regarding the Excitation Source

The excitation source is ground-referenced, not floating, i.e., the -Excitation (EXC -) terminal is connected to the DBK65's ground. The Excitation Source is designed to interface with transducers such that it is the only power source, or its connection is electrically isolated from other power sources.



Tip: Label each transducer with its associated channel/sub-channel information.

2. For a single DBK65 module, connect one end of the P1 cable to the module's male DB37 output connector.
 - For DaqBook applications - use a CA-37-1, or a CA-255-xT cable.
 - For DaqBoard/2000 Series applications - use a CA-37-1 with a DBK200 Series adapter.
 - For DaqBoard [ISA type] boards - use a CA-131-1 cable.
3. Connect the free end of the cable to the P1 port of the LogBook or Daq device. For multiple DBK65 modules, use a CA-37-x, CA-131-x, or a CA-255-xT cable to daisy-chain several modules or an expansion module. For example, three DBK65s could be connected to a LogBook or a Daq device with via a CA-37-3 cable.

Connecting to a BNC Connector (Used with WaveBooks and ZonicBooks)

To connect a BNC connector to a DBK65 channel as signal input we make use of the two-wire scenario. The positive wire comes from the BNC central pin and connects to a DBK65 channel SIG+ terminal. The negative wire connects the negative of the pin hub to a DBK65 channel SIG- terminal. A "BNC to Male Binding Post" connector is convenient for making such two-wire connections.

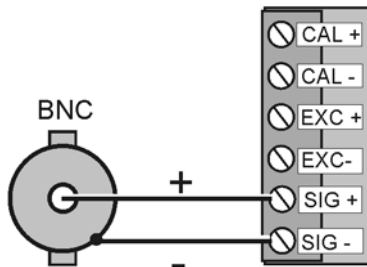

Connecting a BNC to SIG+ and SIG-



BNC to Male Binding Post (for 2-wire connection)

Software Setup

The DBK65 has no special software settings. The software controls are equivalent to those for a direct connection; e.g., for a DaqBoard/2000 Series board there are *Type* selections of x1 to x64, representing the internal gain of that board. When using the DBK65 with that board you will have the same *Type* options, since the DBK65 is always a constant gain of x1.



LogView does not include the means to directly select a DBK65. To use a DBK65 with LogBook: First select DBK80 in LogView. This will recognize the DBK65, but will identify it as a DBK80 (which has eight additional channels). Next do one of the following as applicable:

- (a) If the DBK65 is set to the L sub-address, use channels 0 through 7; *and ignore the displayed unused channels (8 through 15).*
- (b) If the DBK65 is set to the H sub-address, use channels 8 through 15; *and ignore the displayed unused channels (0 through 7).*



Reference Notes:

- **DaqView users** - Refer to Chapter 3, *DBK Setup in DaqView*.
- **LogView users** - Refer to Chapter 4, *DBK Setup in LogView*. See above note.

Calibrating a Transducer using the “Shunt Calibration Technique”

The “shunt calibration” technique involves applying a known resistance across one leg of a transducer. When the resistance is applied, the transducer’s output changes as it would if an actual load was applied. Typically, transducers with internal amplifiers already have a built-in shunt calibration resistor. The shunt calibration resistor can be activated via the DBK65 by use of its rear panel CAL switch.

Prior to making use of the CAL switch, two transducer wires must be connected from the transducer to the applicable channel’s CAL+ and CAL- terminals on the DBK65. The wiring section of the transducer’s calibration data sheet will indicate which terminals (or wires) are to be connected.

To perform shunt calibration:

1. Verify that each transducer to be calibrated has been properly connected to a DBK65 channel’s CAL+ and CAL- terminals.
2. Ensure that the transducer has no initial load, i.e., that it is initially at “zero.”
3. Adjust the data instruments zero-control to obtain a value of 0.0 volts. In the case of 4 to 20 mA outputs, this value would be 4 mA.
4. Slide the CAL switch on the DBK65 rear panel to the “CLOSED” position. Each channel’s internal calibration switch will simultaneously close, activating the calibration shunts [if present].

A step change in the channel output will occur.

5. If the amount of the step change does not agree with the expected change as indicated by the transducer’s calibration data sheet, adjust the transducer as needed. This is typically accomplished with SPAN and/or GAIN control. Refer to the documentation for your specific transducer.
6. Return the “CAL” switch to the “OPEN” position. This removes the shunt calibration resistance from each channel.
7. Recheck the “zero.” Note that there may be some interaction if the GAIN or SPAN control adjustments were large.

In regard to 4 to 20 mA circuits, several full cycles of adjusting the ZERO and SPAN controls may be needed.

DBK65 Specifications

Dimensions: 285 mm W x 220 mm D x 45 mm H (11" x 8.5" x 1.75")

Weight: 1.13 kg (2.5 lbs.)

Operating Temperature: -30°C to +70°C

System Connector: DBK37 male, mates with P1 connectors

Transducer Connectors: 8 removable screw-terminal blocks. Each block has 6 terminals.

Power Connectors: DIN5 Power In, DIN5 Power Out

DC Power Input: +10 to +30 VDC

DC Power Required (through DBK65 Power-In DIN5): 15 V @ 833 mA, 20 V @ 625 mA, assuming max load

DC Power Required (from P1-based host acquisition device): 25 mA from ± 15 V, 755 mW total

Gain Ranges: x1

Inputs: 8 differential voltage inputs

Maximum Voltage Range: ± 10 V

Input Impedance: 20M Ohm

Accuracy: $\pm[0.025\% + 150 \mu\text{V}]$ (typ), $\pm[0.1\% + 250 \mu\text{V}]$ (max)

Noise: $60 \mu\text{V}_{\text{RMS}}$ (typ)

Temperature Coefficient: 10ppm for every degree outside the range of 0° to 50°C

Maximum Signal Input Voltage (without damage): ± 35 V

3 dB Bandwidth: 2.6 MHz

CMRR: 80 dB (typ)

Output Voltage: Each channel, jumper-selectable to +5 V, +10 V, +15 V, and +24 V
or to a custom voltage setting within the range of +5 to +20 V (user set via resistor)

Voltage Accuracy: $\pm 2\%$ (typical)

Current Limit: 100 mA per channel

Load Regulation: 5% (typ)

Total Output: 240 mA max, total of all 8 channels

Accessories and Cables

Rack mount kit	RackDBK3
Shielded P1 T cable for use with DaqBook/2020, LogBook/360, WBK40, WBK41	CA-255-4T
Shielded P1 T cable for use with DaqBook/2001, /2005, LogBook/300, DaqLab/2001, /2005	CA-255-2T
Ribbon cable for use with DaqScan	CA-37-x (see note)

Note: The CA-37-x ribbon cable can also be used in lieu of the CA-255-x molded T cables.

The following 4 graphs illustrate the current limiting capabilities of the DBK65 for 5, 10, 15, and 24 VDC excitation values.

